

JOB# _____

SCROLL RATE:
 0 = NO SCROLL
 1 = FAST SCROLL
 F = SLOW SCROLL

REDUNDANCY:
 0 = SELF-TEST MODE
 1 = LOW REDUNDANCY
 F = HIGH REDUNDANCY

OPTIONAL CHIME PORT

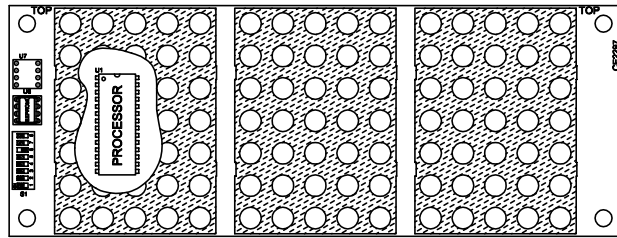

DH330

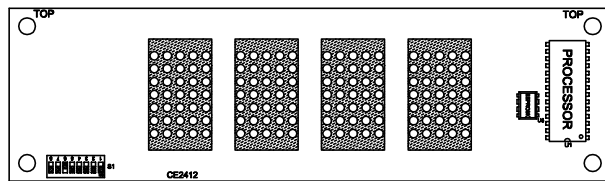

DH410

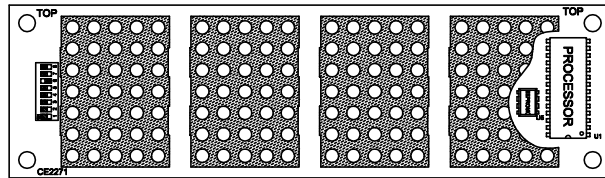

DH420

DIP SWITCH DETAIL

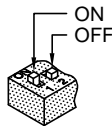
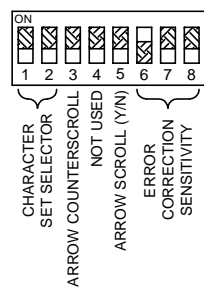

DEFAULT SETTINGS

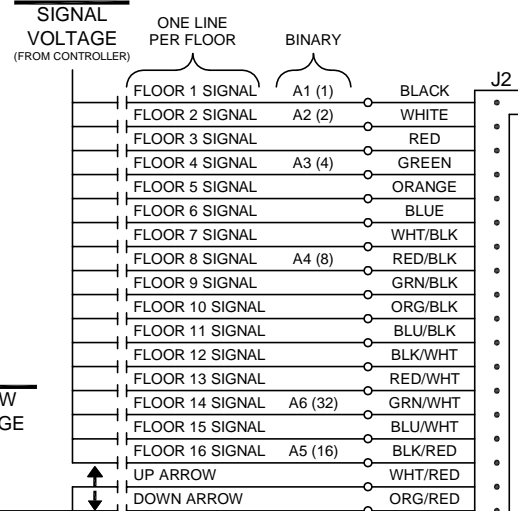
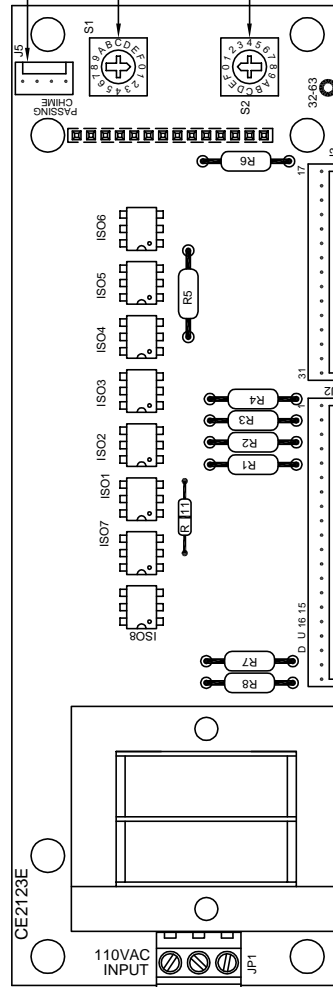
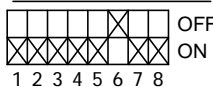

ARROW VOLTAGE

COMMON

ARROW COMMON

ONLY USED FOR ONE LINE PER FLOOR ABOVE 16 FLOORS

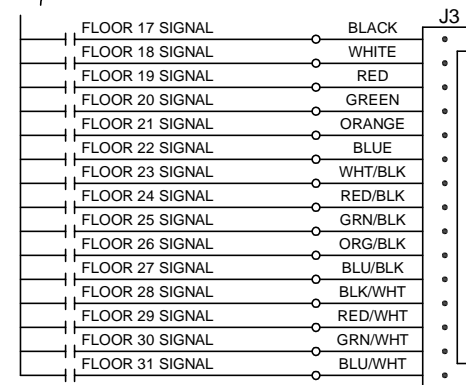

SEE NOTE () BELOW

NOTE A: THE SIGNAL AND ARROW COMMONS ARE TIED TOGETHER ON THE DRIVER BOARD. IF ARROW SOURCE IS DIFFERENT THAN SIGNAL SOURCE, CONTACT TECH SUPPORT AT 419-636-6705 FOR FURTHER INFORMATION.

NOTE B: THE SIGNAL AND ARROW COMMONS HAVE BEEN SEPARATED BY THE FACTORY.

DRIVER BOARD CE2123 _____

DISPLAY BOARD CE _____

ROTARY SWITCH S1 _____

ROTARY SWITCH S2 _____

CODE VERSION _____

Competitor Series

Discrete Input Dot Matrix Displays

DATE DRAWN: 06/01/07	DRAWN BY: DAC	REQUESTED BY: DV	C.E. ELECTRONICS, INC. 2107 Industrial Drive Bryan, Ohio 43306 (419) 636-6705
BOARD NUMBER: 2123	LAST DATE REVISED: -	APPROVED BY:	
PRODUCT DISCRETE DOT MATRIX DISPLAYS			
DWG. NO. DH330_410_420 DIS			REV: -

BINARY FLOOR CHART

BINARY BITS

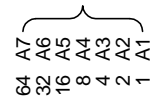

1000000 _____			
0111111 _____	0101111 _____	0011111 _____	0001111 _____
0111110 _____	0101110 _____	0011110 _____	0001110 _____
0111101 _____	0101101 _____	0011101 _____	0001101 _____
0111100 _____	0101100 _____	0011100 _____	0001100 _____
0111011 _____	0101011 _____	0011011 _____	0001011 _____
0111010 _____	0101010 _____	0011010 _____	0001010 _____
0111001 _____	0101001 _____	0011001 _____	0001001 _____
0111000 _____	0101000 _____	0011000 _____	0001000 _____
0110111 _____	0100111 _____	0010111 _____	0000111 _____
0110110 _____	0100110 _____	0010110 _____	0000110 _____
0110101 _____	0100101 _____	0010101 _____	0000101 _____
0110100 _____	0100100 _____	0010100 _____	0000100 _____
0110011 _____	0100011 _____	0010011 _____	0000011 _____
0110010 _____	0100010 _____	0010010 _____	0000010 _____
0110001 _____	0100001 _____	0010001 _____	0000001 _____
0110000 _____	0100000 _____	0010000 _____	0000000 _____

INSTALLATION GUIDE

1. MAKE SURE THE INPUT RESISTORS ARE FULLY SEATED IN THEIR SOCKETS.
2. CONNECT 115VAC TO THE OUTER TERMINALS OF CONNECTOR J1. THE CENTER TERMINAL HAS NO CONNECTION.
3. SET ROTARY SWITCH S2 TO "0" TO START SELF-TEST. THE DISPLAY WILL CYCLE THROUGH THE FLOOR DATA. THIS SHOWS WHAT FLOOR MARKINGS WILL DISPLAY AND ALLOWS ADJUSTMENT OF THE SCROLL RATE AND OPTIONAL PASSING CHIME VOLUME. SET S2 TO AT LEAST "1" (FACTORY DEFAULT IS "2") TO END SELF-TEST.
4. MAKE SURE THE SIGNAL CABLE(S) IS PLUGGED INTO THE DRIVER BOARD CORRECTLY.
5. CONNECT THE SIGNAL CABLE(S) TO THE CONTROLLER. THE VOLTAGE AND DC POLARITY ARE MARKED ON THE REVERSE SIDE. THE UNIT WORKS LIKE A LIGHT BULB; IT NEEDS VOLTAGE FROM COMMON TO THE SELECTED INPUT.
6. IF THE INPUT IS DC AND YOU SUSPECT THE POLARITY IS WRONG, PUT THE SELECTED FLOOR WIRE TO COMMON AND COMMON TO THE SELECTED FLOOR INPUT. IF THE UNIT DISPLAYS THE FLOOR, CONTACT TECH SUPPORT.
7. IF THE INPUT FORMAT IS SINGLE LINE PER FLOOR, ONLY ONE WIRE SHOULD HAVE VOLTAGE PRESENT (WITH REFERENCE TO COMMON) AT ANY TIME.
8. IF THE UNIT DOES NOT SEEM TO WORK PROPERLY, RECHECK THE ABOVE STEPS. IF THE PROBLEM CONTINUES, RECORD THE SERIAL NUMBER FROM THE WHITE LABEL ON THE UNIT AND EXACTLY WHAT THE UNIT DISPLAYS AT EACH FLOOR, THEN CONTACT TECH SUPPORT AT 419-636-6705.

DATE DRAWN: 06/04/07	DRAWN BY: DAC	REQUESTED BY: DV	 C.E. ELECTRONICS, INC. 2107 Industrial Drive Bryan, Ohio 43506 (419) 636-6705
BOARD NUMBER: N/A	LAST DATE REVISED: -	APPROVED BY:	
PRODUCT COMPETITOR SERIES BINARY FLOOR CHART			
DWG. NO. COMP_BINCHART_RS			REV. -